

DS-2TP31B-3AUF

Body Temperature Measurement Camera



The handheld thermal camera, specially designed for body temperature measurement. It's equipped with a 160×120 resolution thermal detector. It helps to quickly detect fever

Key Features

- 160 × 120 resolution
- Thermographic accuracy up to ± 0.5 °C
- 320 × 240 resolution 2.4" LCD display
- Built-in rechargeable Li-ion battery
- Up to 8 hours continuous running

Functions

Thermography

Device detects the real-time temperature, and display it on the screen.

Storage

Device is equipped with replaceable memory card to store recorded captured snapshots, and important data.

Palette

Device supports 4 palettes.



Specification

		Model	DS-2TP31B-3AUF
Parameter		Handheld Thermography Camera	
Thermal Module	Image sensor	Uncooled Focal Plane Arrays	
	Max. Resolution	160 × 120	
	Pixel Pitch	17μm	
	Response waveband	8μm to 14μm	
	NETD	< 40mK (@ 25 °C,F#=1.0)	
	Field of View	37.2° × 50 °	
	Focal length	3.1 mm	
	IFOV (mrad)	5.48 mrad	
	Min. Focus Length	≥ 150 mm	
	Aperture	F 1.1	
Image Display	Monitor	320 × 240 resolution 2.4'' LCD display	
	Palettes	Black hot, White hot, Rainbow, Ironbow	
Thermography	Rules	3 thermometry points: Max. Temperature; Min. Temperature; Center Temperature	
	Thermographic Range	30°C to 45 °C	
	Thermographic Accuracy	±0.5 °C	
Battery	Battery Type	Rechargeable Lithium Battery	
	Battery Operating Time	8 hours continuous running	
	Storage	Replaceable memory card (default 8G, support up to 128G storage)	
	Photo	Thermal image	
	Video	N.A.	
	Language	English	
General	Power	3.7 V DC/0.4 A	
	Power Consumption	Less than 1.2 W	
	Hardware Interface	micro USB	
	Working Temperature	-10 °C to 50 °C (14 °F to 122 °F)	
	Protection level	IP54	
	Drop Test Height	2 m (6.56 feet)	
	Dimension	196 mm × 117 mm × 59 mm (7.7 " × 4.6 " × 2.3 ")	
	Weight	Approx. less than 350 g (0.77 lb)	
Accessory	Power Adaptor, USB cable, 8GB memory card, User manual, Disk, Wrist Strap		

Order Models
DS-2TP31B-3AUF

Box Content

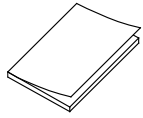

User Manual (×1)

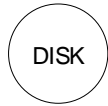

Disk (×1)

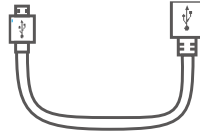

USB Cable (x1)

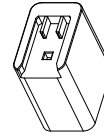

power Adapter
(x1)

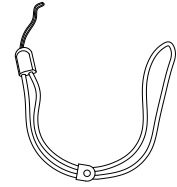

Wrist Strap (x1)

Dimension

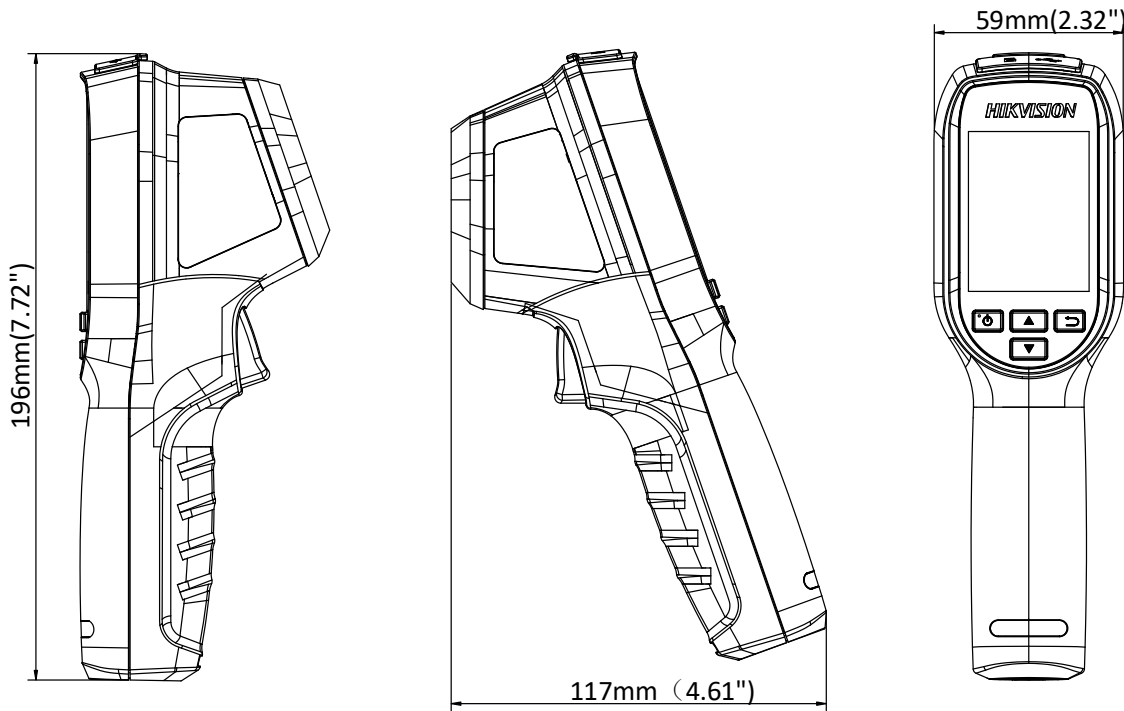

Distributed by



HIKVISION

Headquarters

No.555 Qianmo Road, Binjiang District,
Hangzhou 310051, China
T +86-571-8807-5998
overseasbusiness@hikvision.com

Hikvision USA
T +1-909-895-0400
sales.usa@hikvision.com

Hikvision Australia
T +61-2-8599-4233
salesau@hikvision.com

Hikvision India
T +91-22-28469900
sales@pramahikvision.com

Hikvision Canada
T +1-866-200-8690
sales.canada@hikvision.com

Hikvision Thailand
T +662-275-9949
sales.thailand@hikvision.com

Hikvision Europe
T +31-23-5542770
sales.eu@hikvision.com

Hikvision Italy
T +39-0438-6902
info.it@hikvision.com

Hikvision Brazil
T +55 11 3318-0050
latam.support@hikvision.com

Hikvision Turkey
T +90 (216)521 7070- 7074
sales.tr@hikvision.com

Hikvision Malaysia
T +601-7652-2413
sales.my@hikvision.com

Hikvision UK & Ireland
T +01628-902140
sales.uk@hikvision.com

Hikvision South Africa
Tel: +27 (10) 0351172
sale.africa@hikvision.com

Hikvision France
T +33(0)1-85-330-450
info.fr@hikvision.com

Hikvision Kazakhstan
T +7-727-9730667
nikia.panfilov@hikvision.ru

Hikvision Vietnam
T +84-974270888
sales.vt@hikvision.com

Hikvision UAE
T +971-4-6432080
salesme@hikvision.com

Hikvision Singapore
T +65-6684-4718
sg@hikvision.com

Hikvision Spain
T +34-91-737-16-55
info.es@hikvision.com

Hikvision Tashkent
T +99-87-1238-9438
uzb@hikvision.ru

Hikvision Hong Kong
T +852-2151-1761
info.hk@hikvision.com

Hikvision Russia
T +7-495-669-67-99
saleru@hikvision.com

Hikvision Korea
T +82-1031-731-8817
sales.korea@hikvision.com

Hikvision Poland
T +48-22-460-01-50
info.pl@hikvision.com

Hikvision Indonesia
T +62-21-2933759
Sales.Indonesia@hikvision.com

Hikvision Colombia
sales.colombia@hikvision.com